



**REPAIR PARTS MANUAL**  
**MODEL NO. BA12592RBA**  
**Lawn Tractor**

---

**MCCULLOCH®**

# HOW TO USE THIS MANUAL

This manual is designed to provide the customer with a means to identify the parts on his/her tractor when ordering repair parts. The illustrations may or may not represent the actual assemblies; therefore, it is not recommended to use this manual as a guide to assemble or disassemble the tractor. Some hardware and parts are drawn larger in order to more readily identify them.

Each tractor has its own model number.

The model number for your tractor can be found on the fender under the seat.

When ordering parts, always give the following information:

- Product - "Tractor"
- Model Number - "BA12592RBA"
- Part Number
- Part Description

## TABLE OF CONTENTS

|                         |              |
|-------------------------|--------------|
| <b>SCHEMATIC</b> .....  | <b>3</b>     |
| <b>ELECTRICAL</b> ..... | <b>4-5</b>   |
| <b>CHASSIS</b> .....    | <b>6-7</b>   |
| <b>DRIVE</b> .....      | <b>8-9</b>   |
| <b>STEERING</b> .....   | <b>10-11</b> |
| <b>SEAT</b> .....       | <b>12</b>    |
| <b>DECALS</b> .....     | <b>13</b>    |
| <b>ENGINE</b> .....     | <b>14-15</b> |
| <b>MOWER LIFT</b> ..... | <b>16-17</b> |
| <b>MOWER DECK</b> ..... | <b>18-19</b> |
| <b>BAGGER</b> .....     | <b>20-21</b> |

TRACTOR - - MODEL NO. BA12592RBA, PRODUCT NO. 964 77 46-00  
SCHEMATIC

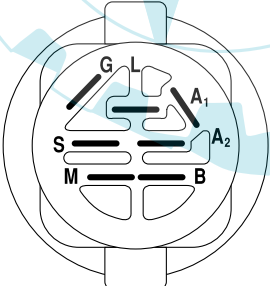
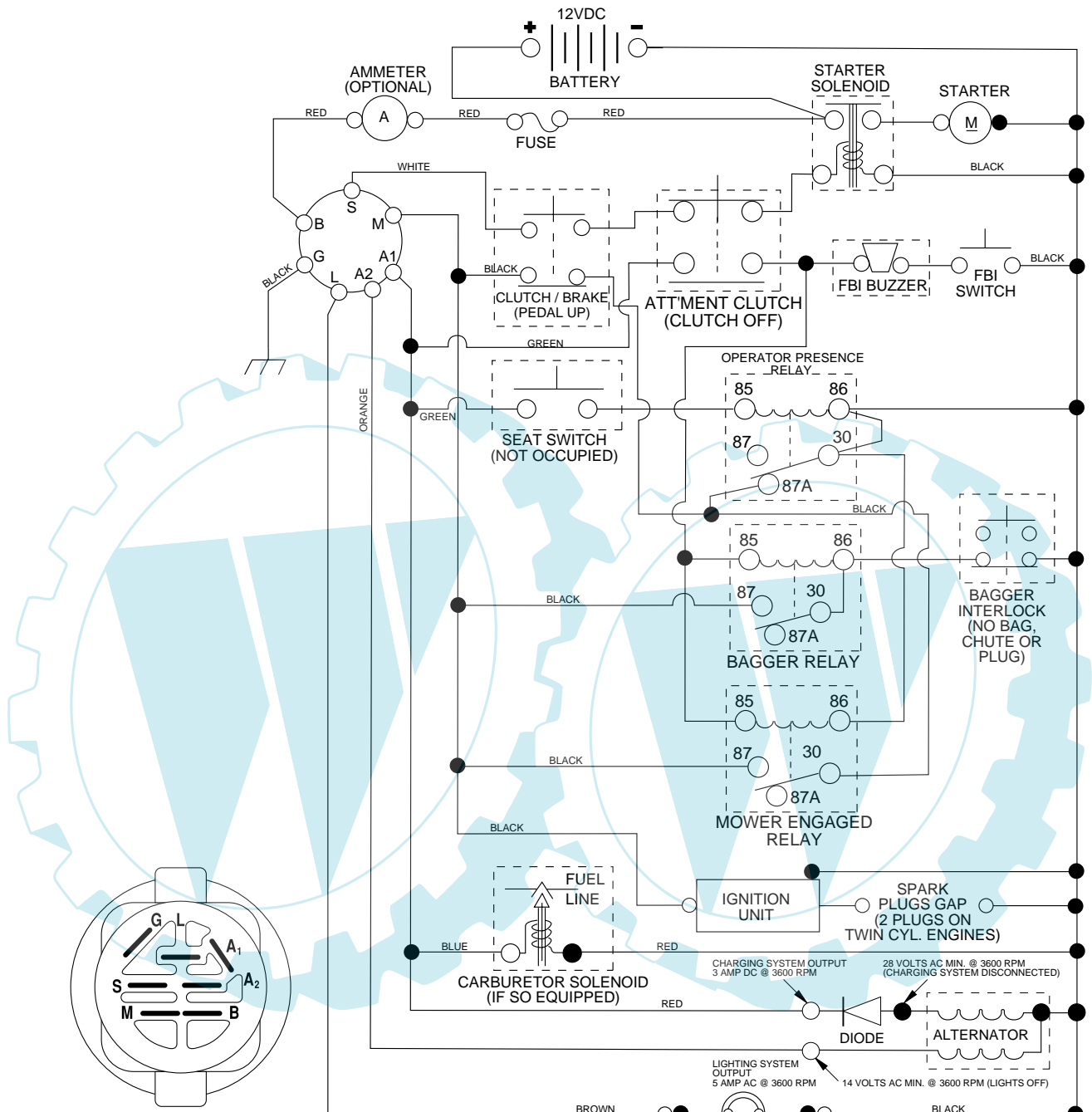

**IGNITION SWITCH**

| POSITION  | CIRCUIT    | "MAKE" |
|-----------|------------|--------|
| OFF       | M+G+A1     | NONE   |
| RUN/LIGHT | B+A1       | A2+L   |
| RUN       | B+A1       | NONE   |
| START     | B + S + A1 | NONE   |

**WIRING INSULATED CLIPS**  
NOTE: IF WIRING INSULATED CLIPS WERE REMOVED FOR SERVICING OF UNIT, THEY SHOULD BE REPLACED TO PROPERLY SECURE YOUR WIRING.

●  
NON-REMOVABLE CONNECTIONS

○  
REMOVABLE CONNECTIONS

**PTO SWITCH**

| POSITION | CIRCUIT             |
|----------|---------------------|
| OFF      | C + G, B + H        |
| ON       | C + F, B + E, A + D |

**HEADLIGHTS**

**NOTE**  
YOUR TRACTOR IS EQUIPPED WITH A SPECIAL ALTERNATOR SYSTEM. THE LIGHTS ARE NOT CONNECTED TO THE BATTERY, BUT HAVE THEIR OWN ELECTRICAL SOURCE. BECAUSE OF THIS, THE BRIGHTNESS OF THE LIGHTS WILL CHANGE WITH ENGINE SPEED. AT IDLE THE LIGHTS WILL DIM. AS THE ENGINE IS SPEEDED UP, THE LIGHTS WILL BECOME THEIR BRIGHTEST.

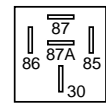

**RELAY**

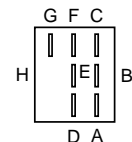

# REPAIR PARTS

TRACTOR - - MODEL NO. BA12592RBA, PRODUCT NO. 964 77 46-00  
ELECTRICAL

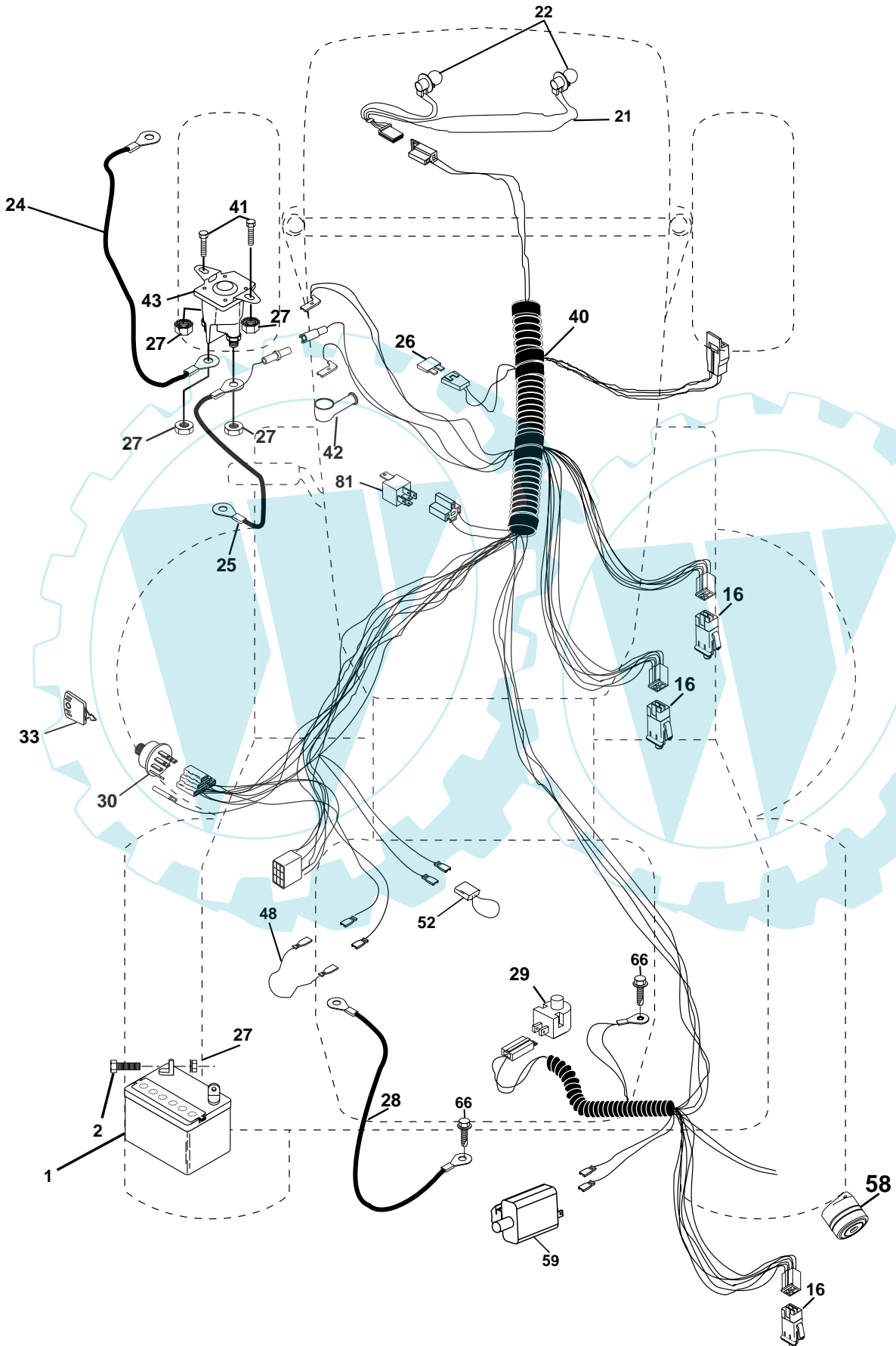

## REPAIR PARTS

TRACTOR - - MODEL NO. BA12592RBA, PRODUCT NO. 964 77 46-00  
ELECTRICAL

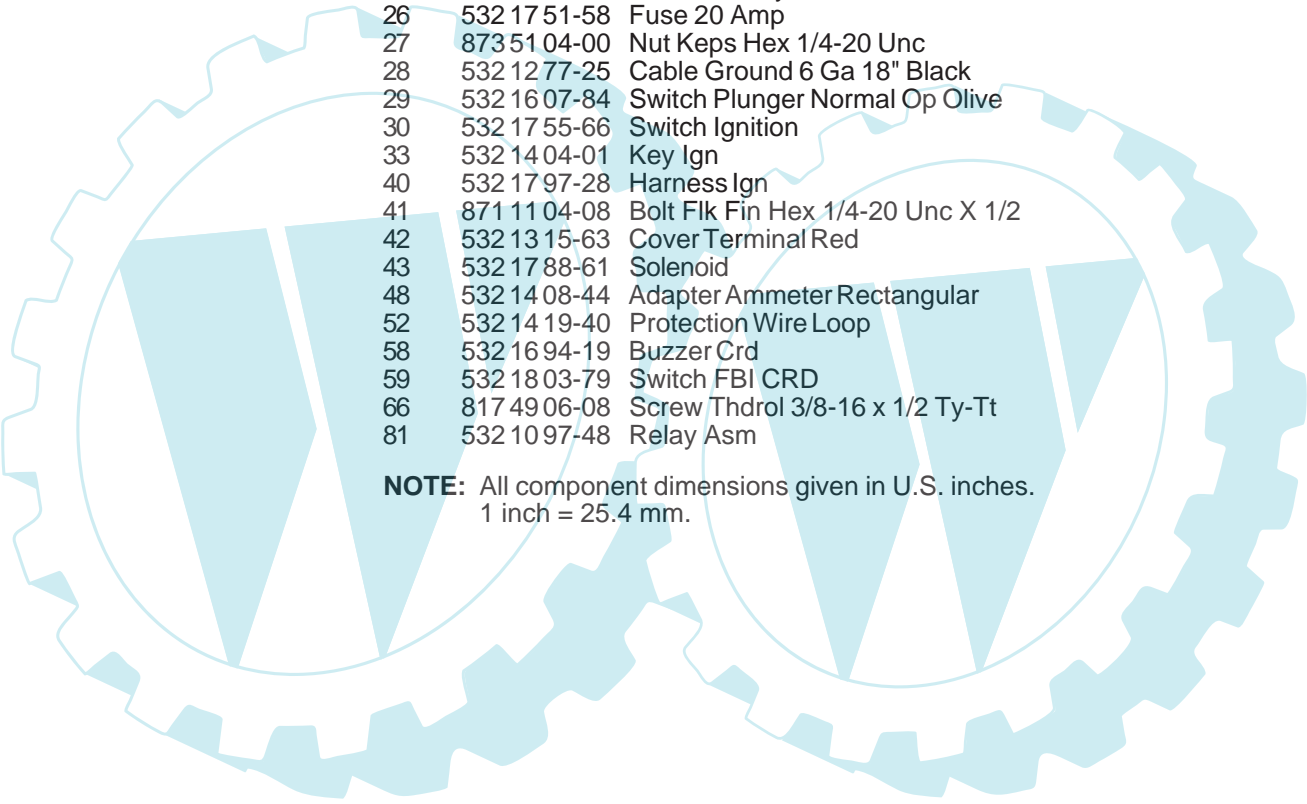

| KEY NO. | PART NO.     | DESCRIPTION                       |
|---------|--------------|-----------------------------------|
| 1       | 532 16 34-65 | Battery                           |
| 2       | 874 76 04-12 | Bolt Hex Hd 1/4-20 Unc X 3/4      |
| 16      | 532 17 61-38 | Switch Interlock Push-In          |
| 21      | 532 17 56-85 | Harness Asm. Light                |
| 22      | 532 00 41-52 | Bulb Light #1156                  |
| 24      | 532 12 47-80 | Cable Starter 6Ga 11" Red         |
| 25      | 532 16 59-87 | Cable Battery Crd 56" Red         |
| 26      | 532 17 51-58 | Fuse 20 Amp                       |
| 27      | 873 51 04-00 | Nut Keps Hex 1/4-20 Unc           |
| 28      | 532 12 77-25 | Cable Ground 6 Ga 18" Black       |
| 29      | 532 16 07-84 | Switch Plunger Normal Op Olive    |
| 30      | 532 17 55-66 | Switch Ignition                   |
| 33      | 532 14 04-01 | Key Ign                           |
| 40      | 532 17 97-28 | Harness Ign                       |
| 41      | 871 11 04-08 | Bolt Flk Fin Hex 1/4-20 Unc X 1/2 |
| 42      | 532 13 15-63 | Cover Terminal Red                |
| 43      | 532 17 88-61 | Solenoid                          |
| 48      | 532 14 08-44 | Adapter Ammeter Rectangular       |
| 52      | 532 14 19-40 | Protection Wire Loop              |
| 58      | 532 16 94-19 | Buzzer Crd                        |
| 59      | 532 18 03-79 | Switch FBI CRD                    |
| 66      | 817 49 06-08 | Screw Thdrol 3/8-16 x 1/2 Ty-Tt   |
| 81      | 532 10 97-48 | Relay Asm                         |

**NOTE:** All component dimensions given in U.S. inches.  
1 inch = 25.4 mm.

# REPAIR PARTS

TRACTOR - - MODEL NO. BA12592RBA, PRODUCT NO. 964 77 46-00  
CHASSIS AND ENCLOSURES

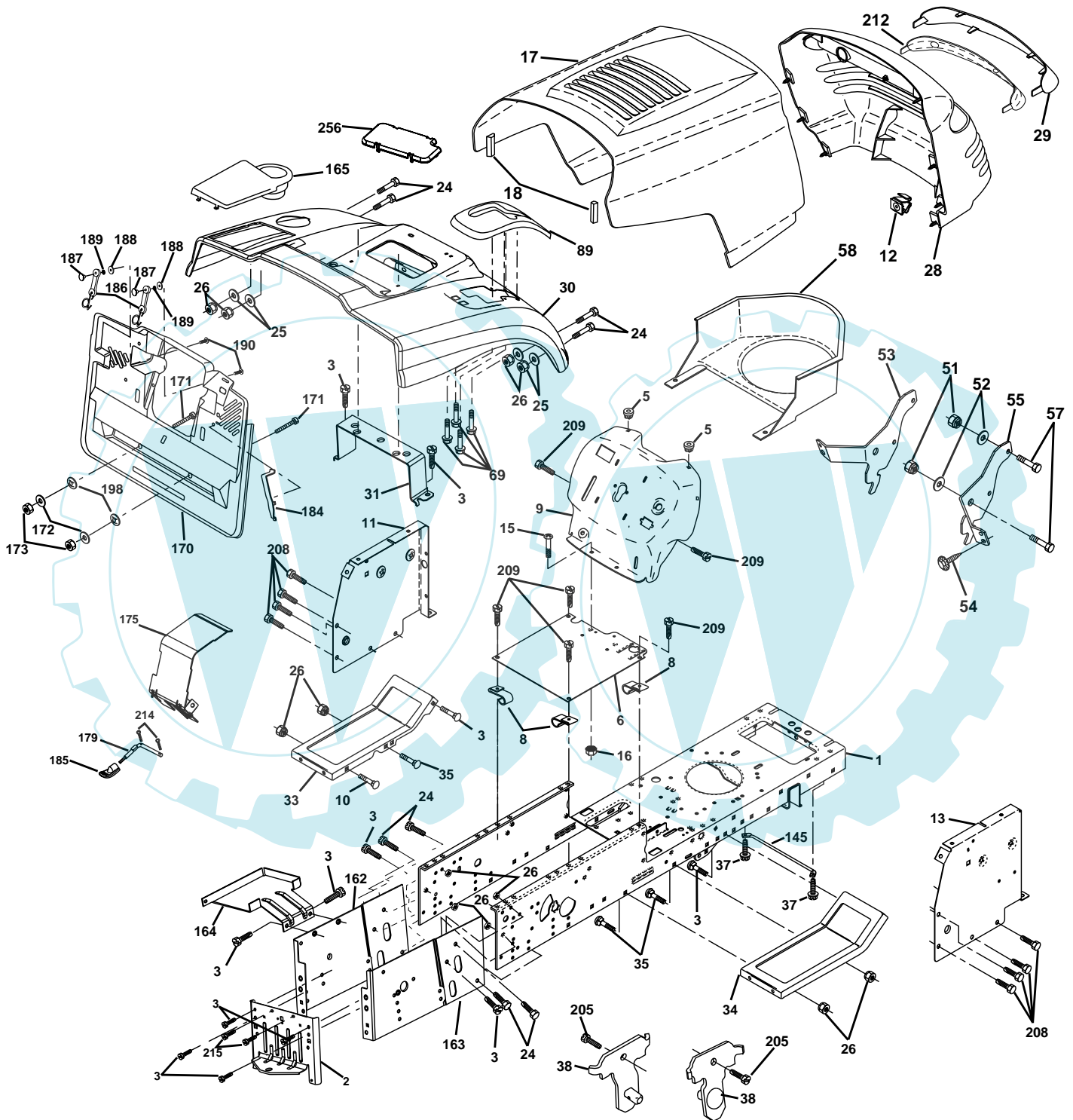

# REPAIR PARTS

TRACTOR - - MODEL NO. BA12592RBA, PRODUCT NO. 964 77 46-00

## CHASSIS AND ENCLOSURES

| KEY NO. | PART NO.     | DESCRIPTION                                  | KEY NO. | PART NO.     | DESCRIPTION                       |
|---------|--------------|--|---------|--------------|-----------------------------------|
| 1       | 532 17 46-20 | Chassis                                      | 58      | 532 15 01-27 | Duct Air Engine Pl/Lt             |
| 2       | 532 18 03-84 | Drawbar                                      | 69      | 532 14 24-32 | Screw Hex 1/4-1/2                 |
| 3       | 817 06 06-12 | Screw 3/8-16 x .75                           | 89      | 532 18 13-88 | Console                           |
| 5       | 532 15 52-72 | Bumper Hood/Dash                             | 145     | 532 15 65-24 | Rod Pivot Chassis/Hood            |
| 6       | 532 15 59-23 | Saddle                                       | 162     | 532 18 03-84 | Bracket Exten Chassis Lh CRD      |
| 8       | 532 12 64-71 | Clip Insulator 13/32 Mtg. Hole               | 163     | 532 18 03-83 | Bracket Exten Chassis Rh CRD      |
| 9       | 532 17 22-43 | Dash   | 164     | 532 16 56-05 | Support Battery CRD               |
| 10      | 872 14 06-08 | Bolt, Carriage 3/8-16 x 3/4                  | 165     | 532 18 13-56 | Cover Battery CRD Lt              |
| 11      | 532 17 49-96 | Panel, Dash, L.H.                            | 170     | 532 17 88-62 | Backplate CRD                     |
| 12      | 532 14 56-60 | Clip Tinnerman Grille P/L                    | 171     | 872 14 06-20 | Bolt Rdhd Sqnk 3/8-16 x 2-1/2 G5  |
| 13      | 532 18 17-19 | Panel, Asm. Dash R.H.                        | 172     | 819 13 20-16 | Washer 13/32 x 1-1/4 x 16 Ga.     |
| 15      | 874 18 05-12 | Screw, Machine, Truss Head 5/16-18 UNC x 3/4 | 173     | 873 51 06-00 | Nut, Keps Hex 3/8-16 UNC          |
| 16      | 873 51 05-00 | Nut  | 175     | 532 18 03-10 | Trap Door CRD                     |
| 17      | 532 18 25-05 | Hood Assembly                                | 179     | 532 18 03-76 | Rod Pivot FBI CRD                 |
| 18      | 532 12 69-38 | Bumper Hood                                  | 184     | 532 17 46-62 | Bracket Actuator Bagger CRD       |
| 24      | 874 78 06-16 | Bolt   | 185     | 532 18 11-01 | Knob Rod                          |
| 25      | 819 13 13-12 | Washer 13/32 x 13/16 x 12 Gauge              | 186     | 532 16 07-93 | Latch Asm Multch Bagger           |
| 26      | 873 80 06-00 | Nut  | 187     | 532 12 50-04 | Nut Weld .327/.304 #10-24         |
| 28      | 532 17 91-01 | Grille Lens Asm                              | 188     | 819 06 12-16 | Washer #10                        |
| 29      | 532 16 81-54 | Lens   | 189     | 810 07 10-00 | Washer Lock #10                   |
| 30      | 532 18 25-06 | Fender                                       | 190     | 871 08 10-10 | Screw Pan Hd Phillips 10-24 x 5/8 |
| 31      | 532 16 51-56 | Bracket, Fender Support                      | 198     | 532 16 89-37 | Nut Push                          |
| 33      | 532 18 25-07 | Footrest, L.H.                               | 205     | 817 49 06-08 | Screw 3/8-16 x 1/2                |
| 34      | 532 18 25-08 | Footrest, R.H.                               | 208     | 817 67 06-08 | Screw Thdrol 3/8-16 x 1/2         |
| 35      | 872 11 06-06 | Bolt   | 209     | 817 00 06-12 | Screw Hex Wsh Thdrol 3/8-16 x 3/4 |
| 37      | 817 49 05-08 | Screw Thdrol 5/16-18 x 1/2 TYT               | 212     | 532 15 62-29 | Insert Lens Reflective            |
| 38      | 532 18 17-48 | Bracket Asm Pivot Mower Rear                 | 214     | 532 12 47-88 | Retainer Spring 1"                |
| 51      | 873 80 04-00 | Nut Lock w/Insert 1/4-20 UNC                 | 215     | 817 06 05-08 | Screw 5/16-18 x 1/2               |
| 52      | 819 09 14-16 | Washer 9/32 x 7/8 x 16 Ga.                   | 256     | 532 18 13-61 | Cover Fender Rack CRD             |
| 53      | 532 14 46-97 | Bracket Grille Lh                            | --      | 532 00 54-79 | Plug, Button                      |
| 54      | 532 16 14-64 | Screw Hex Wshd 8-18 x 7/8                    |         |              |                                   |
| 55      | 532 14 46-96 | Bracket Grille Rh                            |         |              |                                   |
| 57      | 874 78 04-12 | Bolt, Fin Hex 1/4-20 UNC x .75               |         |              |                                   |

**NOTE:** All component dimensions given in U.S. inches.  
1 inch = 25.4 mm.



# REPAIR PARTS

TRACTOR - - MODEL NO. BA12592RBA, PRODUCT NO. 964 77 46-00

## DRIVE

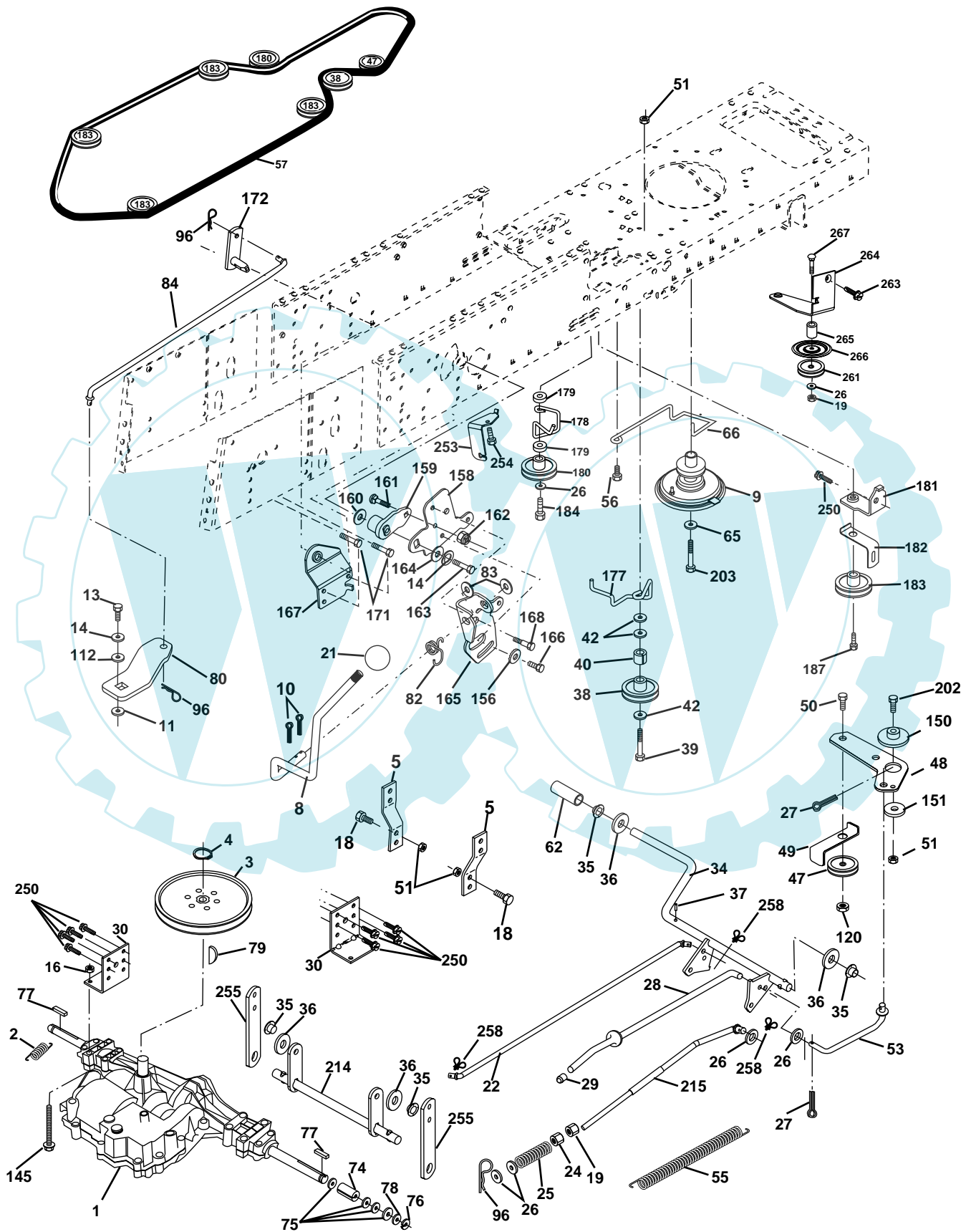



# REPAIR PARTS

TRACTOR - - MODEL NO. BA12592RBA, PRODUCT NO. 964 77 46-00

## DRIVE

| KEY NO. | PART NO.     | DESCRIPTION   | KEY NO. | PART NO.     | DESCRIPTION                        |
|---------|--------------|---|---------|--------------|------------------------------------|
| 1       | -----        | Transaxle Peerless 206-546<br>Order parts from transaxle manufacturer | 80      | 532 14 50-90 | Arm Shift PMST 20" Tires           |
| 2       | 532 14 66-82 | Spring Brake Return   | 82      | 532 16 57-11 | Spring, Torsion                    |
| 3       | 532 16 59-99 | Pulley Transaxle  | 83      | 819 17 12-16 | Washer 17/32 x 3/4 x 16 Ga.        |
| 4       | 812 00 00-28 | Ring Retainer #5100-62  | 84      | 532 16 56-21 | Link Shift CRD Pmst 18" Tires      |
| 5       | 532 12 15-20 | Strap torque 30 degrees   | 96      | 532 12 47-88 | Spring, Retainer 1"                |
| 8       | 532 16 56-19 | Rod Shift Fender Adjust Lt  | 112     | 819 09 12-10 | Washer 9/32 x 3/4 x 10 Ga.         |
| 9       | 532 18 03-54 | Clutch Noram  | 120     | 873 90 06-00 | Nut Lock 3/8-16                    |
| 10      | 876 02 04-16 | Pin, Cotter 1/8 x 1   | 145     | 874 49 05-40 | Bolt Hex FGHD 5/16-18 x Gr 5       |
| 11      | 532 10 57-01 | Washer Plate Shf .3888 sq hole  | 150     | 532 16 58-50 | Bushing, Bellcrank Grnd Dr         |
| 13      | 874 55 04-12 | Bolt 1/4-28 Unf Gr 8 w/patch  | 151     | 819 13 32-10 | Washer 13/32 x 2 x 10 Ga.          |
| 14      | 810 04 04-00 | Washer, Lock Hvy Helical  | 156     | 532 16 60-02 | Washer Srred 5/16 ID x 1.125       |
| 16      | 873 80 05-00 | Nut, Lock Hex w/Ins 5/16-18 UNC                                       | 158     | 532 16 55-89 | Bracket Shift Mount                |
| 18      | 874 78 06-16 | Bolt Hex 3/8-16 UNC x 1 Gr.5  | 159     | 532 16 54-94 | Hub Tapered Flange Shift Lt        |
| 19      | 873 80 06-00 | Nut, Lock Hex w/Wsh 3/8-16 UNC  | 160     | 819 29 20-16 | Washer 29/32 x 1-1/4 x 16 Ga       |
| 21      | 532 10 69-33 | Knob Round 1/2-13 Unc Blk   | 161     | 872 14 04-06 | Bolt Rdhd Sqnk 1/4-20 x 3/4 Gr 5   |
| 22      | 532 17 56-07 | Rod, Brake CRD Main   | 162     | 873 68 04-00 | Nut Crownlock 1/4-20 Unc           |
| 24      | 873 35 06-00 | Nut   | 163     | 874 78 04-16 | Bolt Hex Fin 1/4-20 Unc x 1 Gr 5   |
| 25      | 532 10 68-88 | Spring, Rod, Brake  | 164     | 819 09 10-10 | Washer 5/8 x .281 x 10 Ga.         |
| 26      | 819 13 13-16 | Washer 13/32 x 13/16 x 16 Ga.   | 165     | 532 16 56-23 | Bracket Pivot Lever                |
| 27      | 876 02 04-12 | Pin, Cotter 1/8 x 3/4   | 166     | 532 16 68-80 | Screw 5/16-18 x 5/8                |
| 28      | 532 17 57-65 | Rod, Parking Brake  | 167     | 532 16 55-88 | Bracket Support Shift CRD          |
| 29      | 532 07 16-73 | Cap, Parking Brake  | 168     | 532 16 54-92 | Bolt Shoulder 5/16-18 x .561       |
| 30      | 532 17 49-73 | Bracket, Mfg. Transaxle   | 171     | 817 49 06-08 | Screw Thdrol 3/8-16 x 1/2 Ty-Tt    |
| 34      | 532 17 55-78 | Shaft, Asm Pedal Foot CRD   | 172     | 532 16 56-35 | Shaft Asm Shift Front CRD PMST     |
| 35      | 532 12 01-83 | Bearing, Nylon  | 177     | 532 16 59-32 | Keeper Flat Idler 3.06" CRD        |
| 36      | 819 21 16-16 | Washer 21/32 x 1 x 16 Ga.   | 178     | 532 16 59-33 | Keeper Belt Idler 1.88" CRD        |
| 37      | 532 12 49-63 | Pin, Roll 3/16 x 1"   | 179     | 532 12 09-58 | Washer Sintered                    |
| 38      | 532 16 59-36 | Pulley, Flat  | 180     | 532 16 56-30 | Pulley Flat Composite 3.06"        |
| 39      | 874 76 06-44 | Bolt Fin Hex 3/8-16 Unc x 2-3/4                                       | 181     | 532 18 02-11 | Bracket Idler Ground Drive CRD     |
| 40      | 532 12 49-65 | Spacer, Split 395 x 59 Bzp  | 182     | 532 16 56-34 | Keeper Belt 2.5" Od V-Idler CRD    |
| 42      | 819 13 13-12 | Washer 13/32 x 13/16 x 12 Ga.   | 183     | 532 17 90-50 | Pulley V-Idler 2.50" Od CRD        |
| 47      | 532 12 77-83 | Pulley, Idler, V Groove Plasic  | 184     | 817 49 06-44 | Screw Hexwsh Thdrol 3/8-16 x 2-3/4 |
| 48      | 532 15 44-07 | Bellcrank Clutch Grnd Drv   | 187     | 817 58 05-20 | Screw 5/16-18 x 1.25               |
| 49      | 532 12 32-05 | Retainer, Belt Style Spring   | 202     | 872 11 06-14 | Bolt Carr. SH 3/8-16 x 1-3/4 Gr. 5 |
| 50      | 874 76 06-24 | Bolt Hex Hd 3/8-16 UNC x 1-1/2  | 203     | 871 17 07-80 | Bolt Hex 7/16-20 x 5               |
| 51      | 873 68 06-00 | Nut, Crownlock 3/8-16 UNC   | 214     | 532 17 56-09 | Shaft Asm. Brake                   |
| 53      | 532 10 57-10 | Link, Clutch 7.66   | 215     | 532 17 56-51 | Rod Brake Secondary                |
| 55      | 532 10 57-09 | Spring, Return, Clutch  | 250     | 817 06 06-12 | Screw 3/8-16 x .75                 |
| 56      | 874 76 06-20 | Bolt, Hex 3/8-16 UNC x 1-1/4  | 253     | 532 17 50-28 | Bracket Cable Chassis              |
| 57      | 532 16 56-31 | V-Belt Kev PMST CRD   | 254     | 817 06 06-16 | Screw 3/8-16 x 1.0                 |
| 62      | 532 12 48-72 | Cover, Pedal  | 255     | 532 17 56-08 | Brace Shaft Brake                  |
| 65      | 810 04 07-00 | Washer  | 258     | 532 17 80-62 | Clip Retainer                      |
| 66      | 532 15 47-78 | Keeper, Belt Engine F-Proof   | 261     | 532 17 34-38 | Pulley Idler Flat                  |
| 74      | 532 13 70-57 | Spacer Axle   | 263     | 817 00 06-12 | Screw Hxwsh Thdr 3/8-16 x 3/4      |
| 75      | 532 12 17-49 | Washer 25/32 x 1-1/4 x 16 Ga.   | 264     | 532 18 19-95 | Bracket Clutch Mtg.                |
| 76      | 812 00 00-01 | Ring, E   | 265     | 532 18 20-13 | Spacer Idler Chassis               |
| 77      | 532 12 35-83 | Key, Square   | 266     | 532 18 20-61 | Shield Idler                       |
| 78      | 532 12 17-48 | Washer 25/32 x 1-5/8 x 16 Ga.   | 267     | 872 14 06-24 | Bolt Rdhd Sqnk 3/8-16 x 3          |
| 79      | 532 12 50-96 | Key Woodruff  |         |              |                                    |

**NOTE:** All component dimensions given in U.S. inches  
1 inch = 25.4 mm

# REPAIR PARTS

TRACTOR - - MODEL NO. BA12592RBA, PRODUCT NO. 964 77 46-00  
STEERING ASSEMBLY

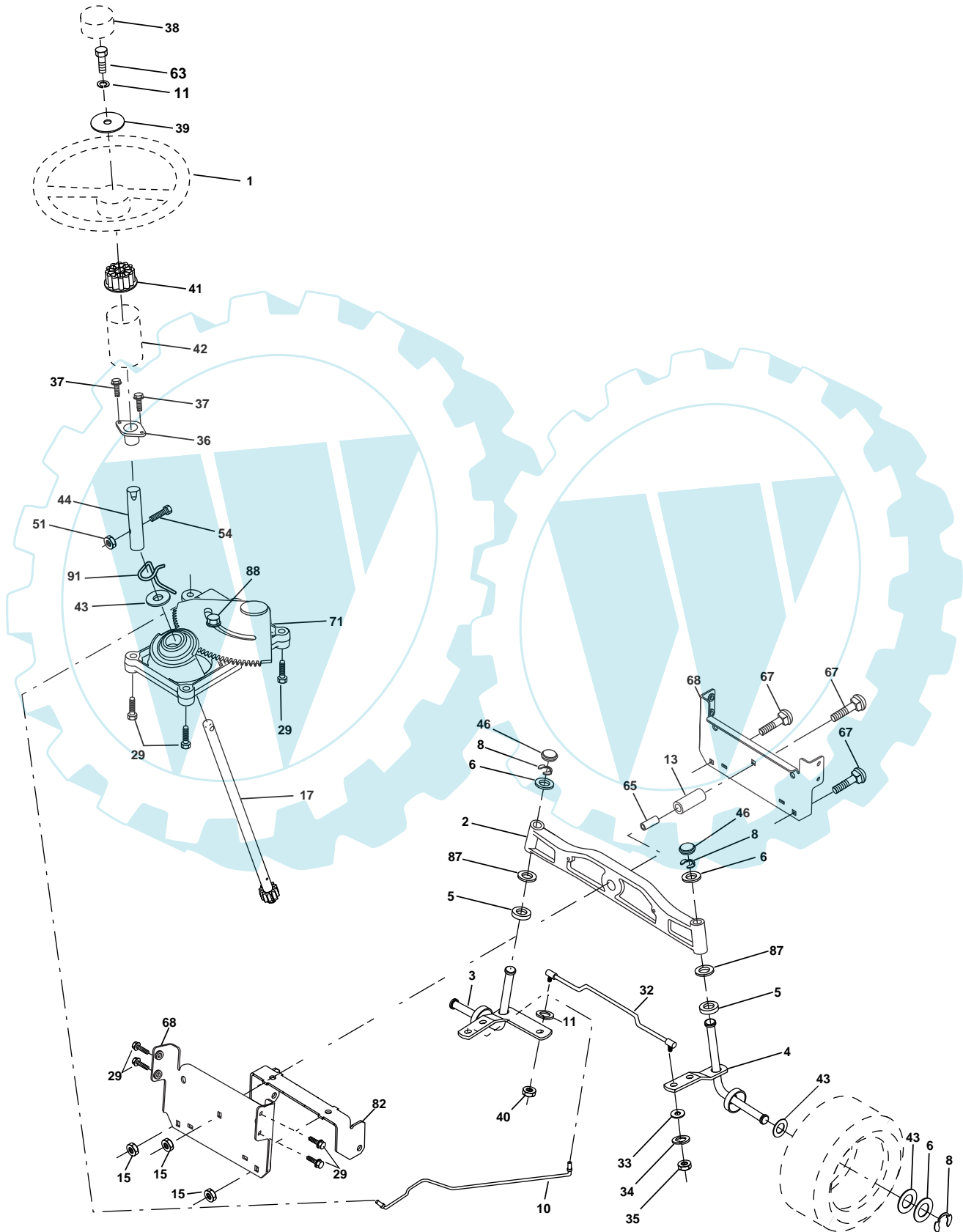

## REPAIR PARTS

TRACTOR - - MODEL NO. BA12592RBA, PRODUCT NO. 964 77 46-00  
STEERING ASSEMBLY

| KEY NO. | PART NO.     | DESCRIPTION                        |
|---------|--------------|------------------------------------|
| 1       | 532 17 59-04 | Steering Wheel                     |
| 2       | 532 17 23-93 | Cast Iron Axle Assembly            |
| 3       | 532 16 98-40 | Spindle Assembly, L.H.             |
| 4       | 532 16 98-39 | Spindle Assembly, R.H.             |
| 5       | 532 12 49-31 | Bearing, Race, Thrust, Hardened    |
| 6       | 532 12 17-48 | Washer 25/32 x 1-5/8 x 16 Gauge    |
| 8       | 812 00 00-29 | Ring, Klip                         |
| 10      | 532 17 51-21 | Link, Drag                         |
| 11      | 810 04 06-00 | Washer, Lock                       |
| 13      | 532 13 65-18 | Spacer Brg Axle Front              |
| 15      | 532 14 52-12 | Nut, Hexflange Lock                |
| 17      | 532 17 78-76 | Shaft Assembly, Steering           |
| 29      | 817 06 06-12 | Screw, 3/8-16 x 3/4                |
| 32      | 532 17 01-62 | Rod, Tie                           |
| 33      | 819 11 12-16 | Washer 11/32 x 3/4 x 16 Ga         |
| 34      | 810 04 05-00 | Washer Lock Hvy Hlcl Spr 5/16      |
| 35      | 873 54 05-00 | Nut Crownlock 5/16-24 Unf          |
| 36      | 532 15 50-99 | Bushing, Steering                  |
| 37      | 532 15 29-27 | Screw TT #10-32 x 5 x 3/8 Flange   |
| 38      | 532 17 59-05 | Cap Wheel Steer                    |
| 39      | 819 13 38-12 | Washer 13/32 x 2-3/8 x 12 Gauge    |
| 40      | 532 12 47-01 | Nut Lock Center 3/8-24 Unf         |
| 41      | 532 10 07-11 | Adaptor, Steering Wheel            |
| 42      | 532 16 96-33 | Boot, Steering Dash P/L Mtl        |
| 43      | 532 12 17-49 | Washer 25/32 x 1-1/4 x 16 Gauge    |
| 44      | 532 15 37-20 | Extension Steering Non-Adjust      |
| 46      | 532 12 12-32 | Cap, Spindle                       |
| 51      | 873 80 05-00 | Nut Lock Hx W/Ins 5/16-18 UNC      |
| 54      | 874 78 05-20 | Bolt Fin Hex 5/16-18 UNC x 1-1/4   |
| 63      | 874 78 06-16 | Bolt Fin Hex 3/8-16 unc. x 1 Gr. 5 |
| 65      | 532 16 03-67 | Spacer Brace Axle                  |
| 67      | 872 14 06-18 | Bolt Rdhd Sq 3/8-16 UNC x 2-1/4    |
| 71      | 532 17 51-46 | Steering Asm.                      |
| 68      | 532 16 98-27 | Brace Axle                         |
| 82      | 532 16 98-35 | Bracket Susp Chassis Front         |
| 87      | 532 17 39-66 | Washer Flat .781 x 1-1/2 x .14     |
| 88      | 532 17 51-18 | Bolt Shoulder 7/16-20 Unc          |
| 91      | 532 17 55-53 | Clip Steering                      |

**NOTE:** All component dimensions given in U.S. inches.  
1 inch = 25.4 mm.

# REPAIR PARTS

TRACTOR - - MODEL NO. BA12592RBA, PRODUCT NO. 964 77 46-00  
SEAT ASSEMBLY

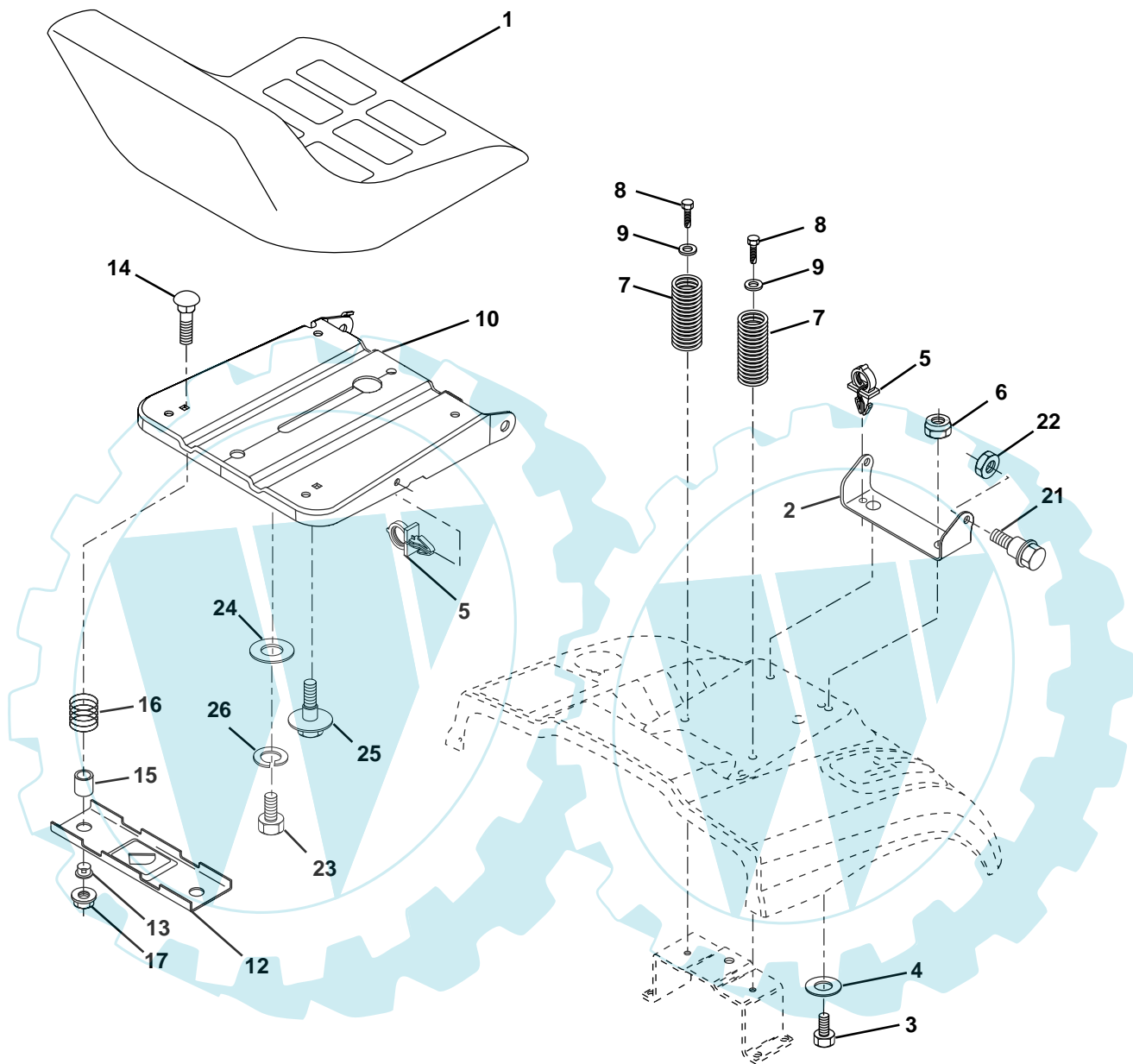

| KEY NO. | PART NO.     | DESCRIPTION                    |
|---------|--------------|--------------------------------|
| 1       | 532 14 01-16 | Seat                           |
| 2       | 532 14 05-51 | Bracket Pnt Pivot Seat (blk )  |
| 3       | 871 11 06-16 | Bolt Fin Hex 3/8-16 Unc x 1    |
| 4       | 819 13 16-10 | Washer Flat 13/32 x 1 x 10 Ga. |
| 5       | 532 14 50-06 | Clip Push In Hinged            |
| 6       | 873 80 06-00 | Nut Lock Hex 3/8-16 Unc        |
| 7       | 532 12 41-81 | Spring Seat Cprsn 2 250 Blk Zi |
| 8       | 817 00 06-16 | Screw 3/8-16 X 1-1/2           |
| 9       | 819 13 16-14 | Washer 13/32 X 1 X 14 Ga       |
| 10      | 532 17 48-94 | Pan Pnt Seat (blk )            |
| 12      | 532 12 12-46 | Bracket Pnt Mounting Switch    |
| 13      | 532 12 12-48 | Bushing Snap Blk Nyl 50 Id     |

| KEY NO. | PART NO.     | DESCRIPTION                    |
|---------|--------------|--------------------------------|
| 14      | 872 05 04-12 | Bolt Rdhd Sht Nk 1/4-20x1-1/2  |
| 15      | 532 13 43-00 | Spacer Split                   |
| 16      | 532 12 12-50 | Spring Cprsn Plate SW 1.310 Ga |
| 17      | 532 12 39-76 | Nut Lock 1/4 Lge Flg Gr 5 Zinc |
| 21      | 532 17 18-52 | Bolt Shoulder 5/16-18 Unc-2A   |
| 22      | 873 80 05-00 | Nut Hex Lock w/Ins 5/16-18     |
| 23      | 871 11 08-14 | Bolt Hex Black                 |
| 24      | 819 17 19-12 | Washer 17/32 X 1-3/16 X 12 Ga. |
| 25      | 532 12 70-18 | Bolt Shoulder 5/16-18 X 62     |
| 26      | 810 04 08-00 | Washer Lock Hvy Hlcl Spr 1/2   |

**NOTE:** All component dimensions given in U.S. inches.  
1 inch = 25.4 mm

# REPAIR PARTS

TRACTOR - - MODEL NO. BA12592RBA, PRODUCT NO. 964 77 46-00

## DECALS

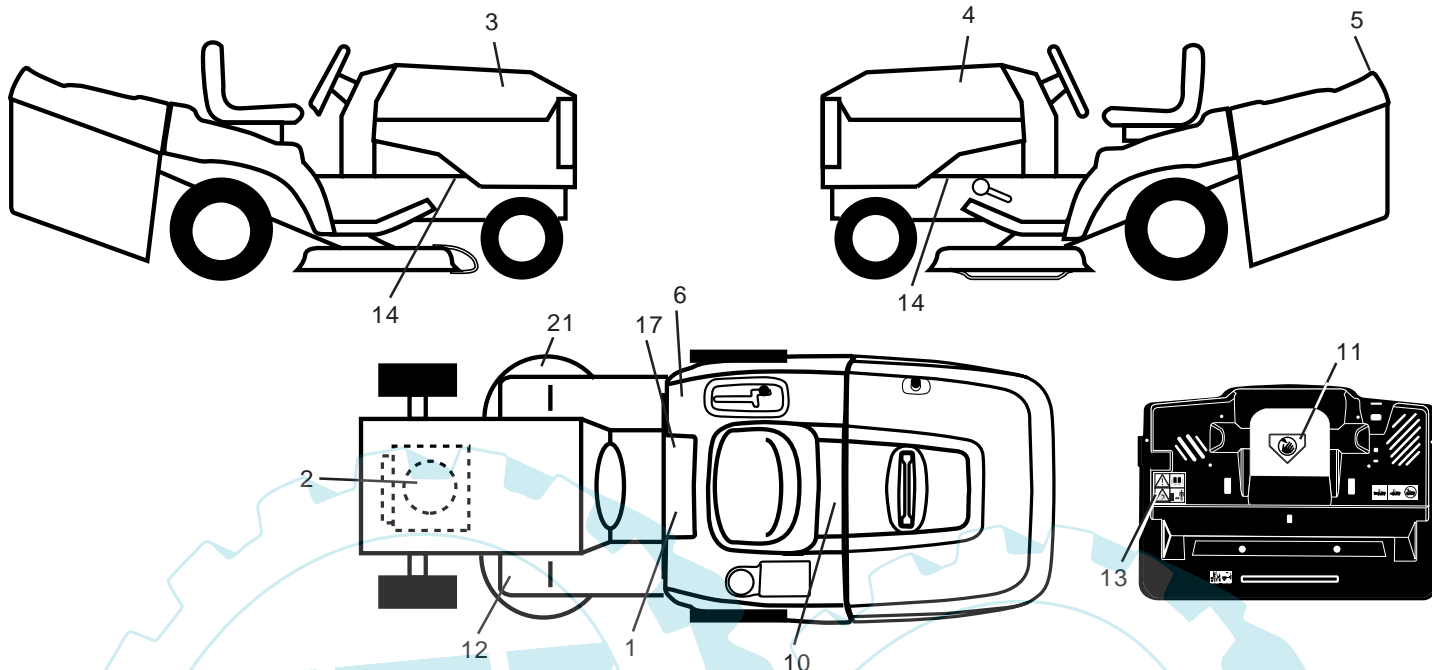

| KEY NO. | PART NO.     | DESCRIPTION                   |
|---------|--------------|-------------------------------|
| 1       | 532 14 54-98 | Decal Read Owner's Manual Sym |
| 2       | 532 17 08-41 | Decal Hp Engine               |
| 3       | 532 18 16-56 | Decal Hood                    |
| 4       | 532 18 16-57 | Decal Hood                    |
| 5       | 532 18 16-23 | Decal Bagger                  |
| 6       | 532 18 04-32 | Decal 100 DBA/CE              |
| 10      | 532 14 50-05 | Decal Bat Dan/Poi P/L Sym Wpn |
| 11      | 532 14 54-94 | Decal Mower Cut Finger Symbol |
| 12      | 532 15 97-37 | Decal Brake/Clutch Symbol Lt  |

| KEY NO. | PART NO.     | DESCRIPTION                |
|---------|--------------|----------------------------|
| 13      | 532 18 04-35 | Decal Warn Back Plate CRD  |
| 14      | 532 15 97-36 | Decal Chassis Hot Muffler  |
| 17      | 532 14 08-37 | Decal Saddle Brake Parking |
| 21      | 532 16 62-86 | Decal Hex Belt Sch 92 CRD  |
| —       | 532 13 83-11 | Decal Lift Handle          |
| —       | 532 18 08-40 | Manual Operator's (Euro)   |
| —       | 532 08 24-49 | Manual Operator's (CZ)     |
| —       | 532 18 08-41 | Manual Parts               |

## WHEELS & TIRES

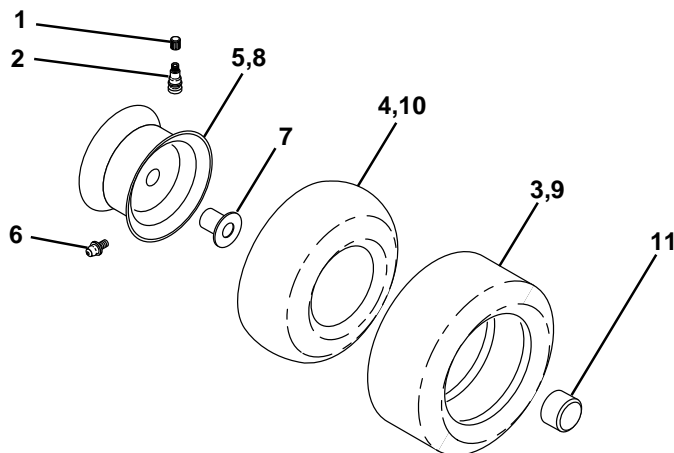

| KEY NO. | PART NO.     | DESCRIPTION                    |
|---------|--------------|--------------------------------|
| 1       | 532 05 91-92 | Cap Value Tire                 |
| 2       | 532 06 51-39 | Stem Value                     |
| 3       | 532 10 62-22 | Tire F Ts 15 X 6 0 - 6 Service |
| 4       | 532 05 99-04 | Tube Inner Front #35060        |
| 5       | 532 12 51-21 | Rim Asm 6" front Service       |
| 6       | 532 12 49-57 | Fitting Grease                 |
| 7       | 532 12 49-59 | Bearing Flange                 |
| 8       | 532 12 51-22 | Rim Asm 8" rear Service        |
| 9       | 532 12 46-35 | Tire R Ts 20 x 8-8 Service     |
| 10      | 532 12 49-26 | Tube Rear 9 5 X 8 Service      |
| 11      | 532 17 50-39 | Cap Axle Blk 1 50 X 1 00       |
| --      | 532 14 43-34 | Sealant, Tire (10 oz. tube)    |

**NOTE:** All component dimensions given in U.S. inches  
1 inch = 25.4 mm



# REPAIR PARTS

TRACTOR - - MODEL NO. BA12592RBA, PRODUCT NO. 964 77 46-00  
ENGINE

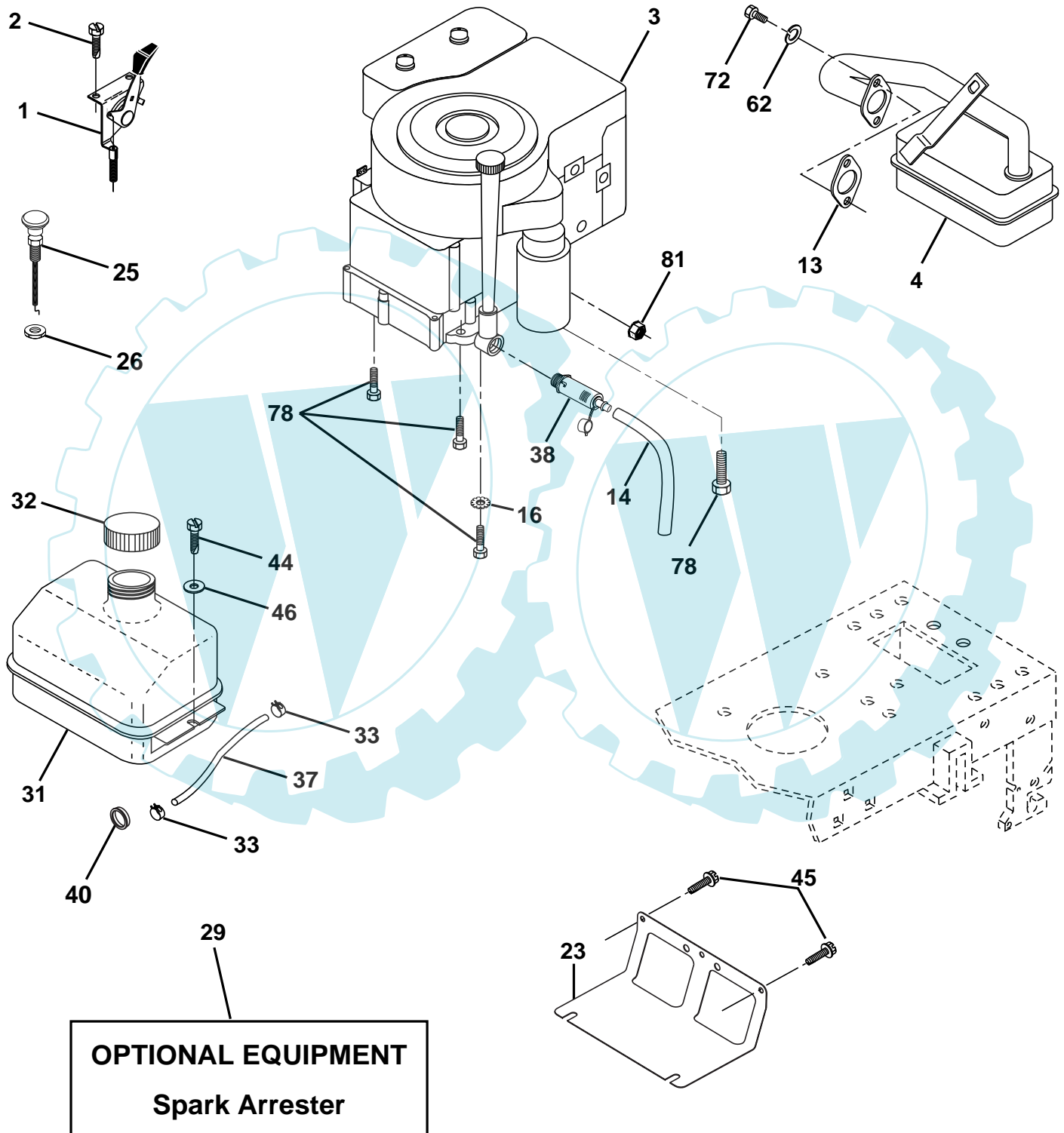



## REPAIR PARTS

TRACTOR - - MODEL NO. BA12592RBA, PRODUCT NO. 964 77 46-00  
ENGINE

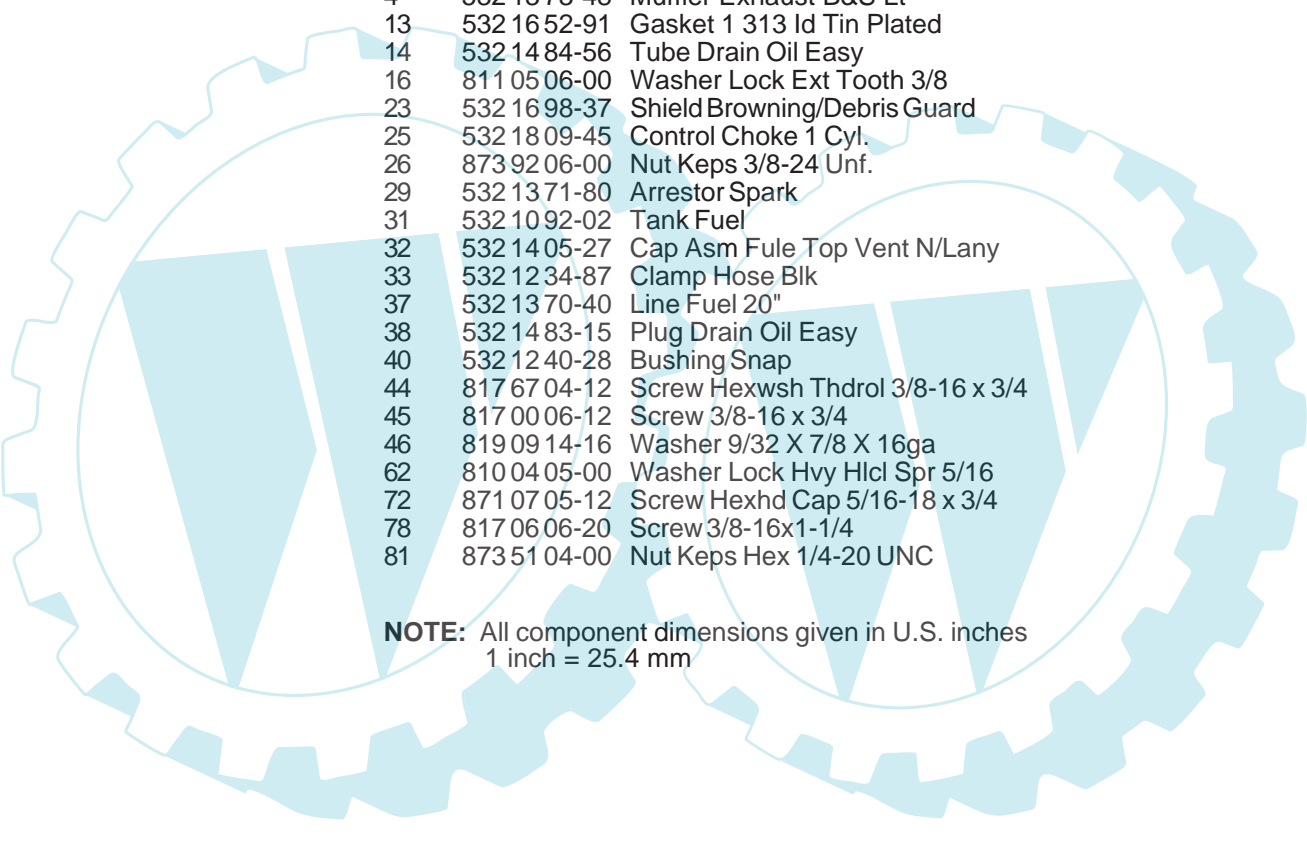

| KEY NO. | PART NO.     | DESCRIPTION   |
|---------|--------------|---|
| 1       | 532 17 05-51 | Control Throt/Ch  |
| 2       | 817 72 04-08 | Screw Hex Thd Cut 1/4-20x5/8 T                                    |
| 3       | -----        | Engine B&S Model 289707<br>(Order Parts from Engine Manufacturer) |
| 4       | 532 13 73-48 | Muffler Exhaust B&S Lt  |
| 13      | 532 16 52-91 | Gasket 1 313 Id Tin Plated  |
| 14      | 532 14 84-56 | Tube Drain Oil Easy   |
| 16      | 811 05 06-00 | Washer Lock Ext Tooth 3/8   |
| 23      | 532 16 98-37 | Shield Browning/Debris Guard                                      |
| 25      | 532 18 09-45 | Control Choke 1 Cyl.  |
| 26      | 873 92 06-00 | Nut Keps 3/8-24 Unf.  |
| 29      | 532 13 71-80 | Arrestor Spark  |
| 31      | 532 10 92-02 | Tank Fuel   |
| 32      | 532 14 05-27 | Cap Asm Fule Top Vent N/Lany                                      |
| 33      | 532 12 34-87 | Clamp Hose Blk  |
| 37      | 532 13 70-40 | Line Fuel 20"   |
| 38      | 532 14 83-15 | Plug Drain Oil Easy   |
| 40      | 532 12 40-28 | Bushing Snap  |
| 44      | 817 67 04-12 | Screw Hexwsh Thdrol 3/8-16 x 3/4                                  |
| 45      | 817 00 06-12 | Screw 3/8-16 x 3/4  |
| 46      | 819 09 14-16 | Washer 9/32 X 7/8 X 16ga  |
| 62      | 810 04 05-00 | Washer Lock Hvy Hlcl Spr 5/16                                     |
| 72      | 871 07 05-12 | Screw Hexhd Cap 5/16-18 x 3/4                                     |
| 78      | 817 06 06-20 | Screw 3/8-16x1-1/4  |
| 81      | 873 51 04-00 | Nut Keps Hex 1/4-20 UNC   |

**NOTE:** All component dimensions given in U.S. inches  
1 inch = 25.4 mm

# REPAIR PARTS

TRACTOR - - MODEL NO. BA12592RBA, PRODUCT NO. 964 77 46-00  
MOWER LIFT

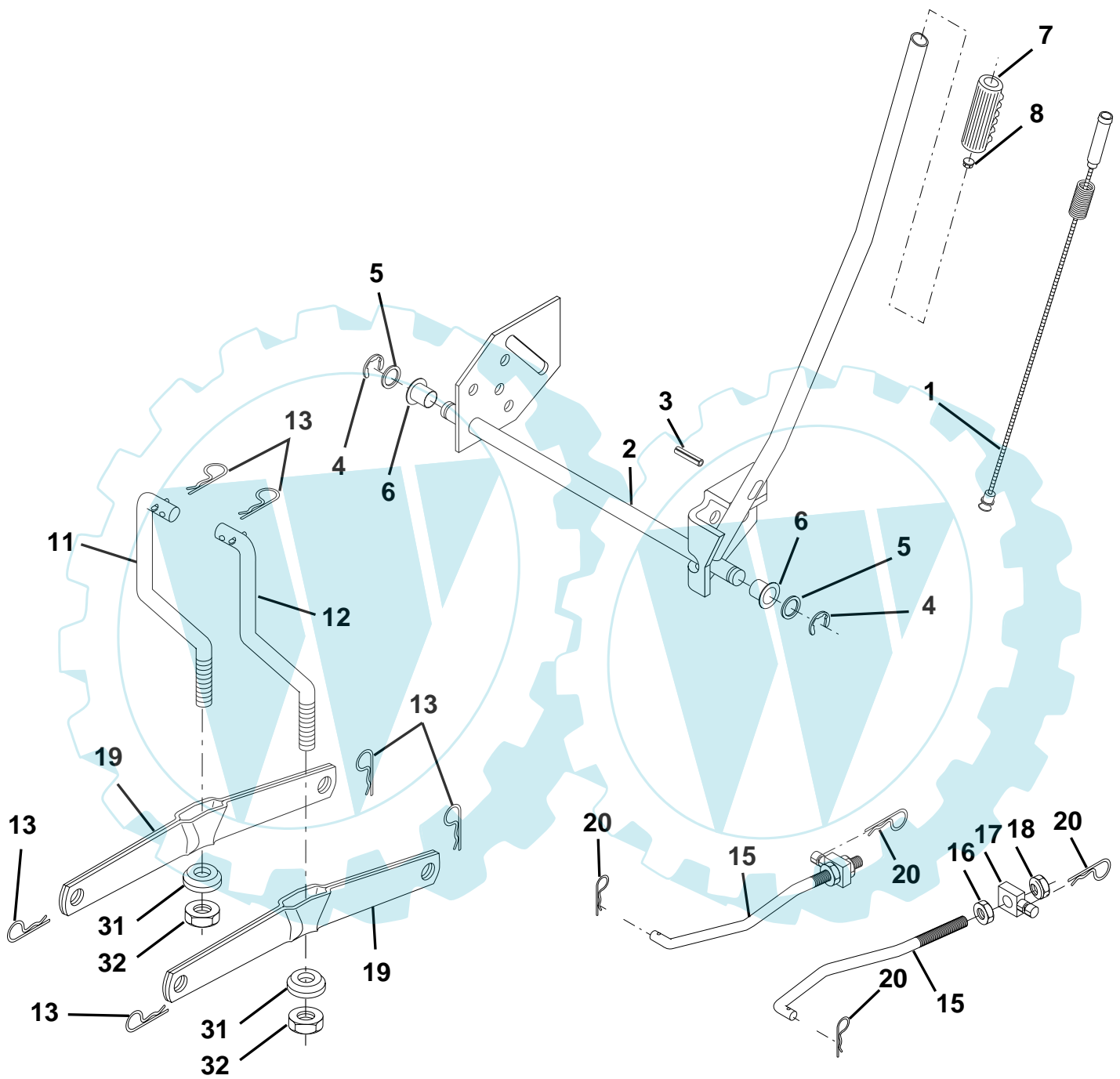

## REPAIR PARTS

TRACTOR - - MODEL NO. BA12592RBA, PRODUCT NO. 964 77 46-00  
MOWER LIFT

| KEY NO. | PART NO.     | DESCRIPTION                       |
|---------|--------------|-----------------------------------|
| 1       | 532 15 94-60 | Washer Asm Inner Spring W/Plunger |
| 2       | 532 15 94-71 | Shaft Asm. Lift                   |
| 3       | 532 10 57-67 | Pin Groove                        |
| 4       | 812 00 00-02 | E Ring #5133-62                   |
| 5       | 819 21 16-21 | Washer 21/32 x 1 x 21 Ga.         |
| 6       | 532 12 01-83 | Bearing Nylon                     |
| 7       | 532 10 94-13 | Grip Handle Bicycle               |
| 8       | 532 12 45-26 | Button Plunger Black              |
| 11      | 532 16 58-29 | Link Asm Lift L.H.                |
| 12      | 532 16 58-31 | Link Asm Lift R.H.                |
| 13      | 532 12 46-70 | Retainer Spring                   |
| 15      | 532 17 32-88 | Link Front                        |
| 16      | 873 35 08-00 | Nut Jam Hex 1/2-13 Unc            |
| 17      | 532 17 56-89 | Trunnion Blk Zinc                 |
| 18      | 873 80 08-00 | Nut Lock w/Wsh 1/2-13 Unc         |
| 19      | 532 13 98-68 | Arm Suspension Mower              |
| 20      | 532 16 35-52 | Retainer Spring                   |
| 31      | 532 16 98-65 | Bearing, Pvt. Lift.               |
| 32      | 873 54 06-00 | Nut Crownlock 3/8-24              |

**NOTE:** All component dimensions given in U.S. inches  
1 inch = 25.4 mm

# REPAIR PARTS

TRACTOR - - MODEL NO. BA12592RBA, PRODUCT NO. 964 77 46-00  
MOWER

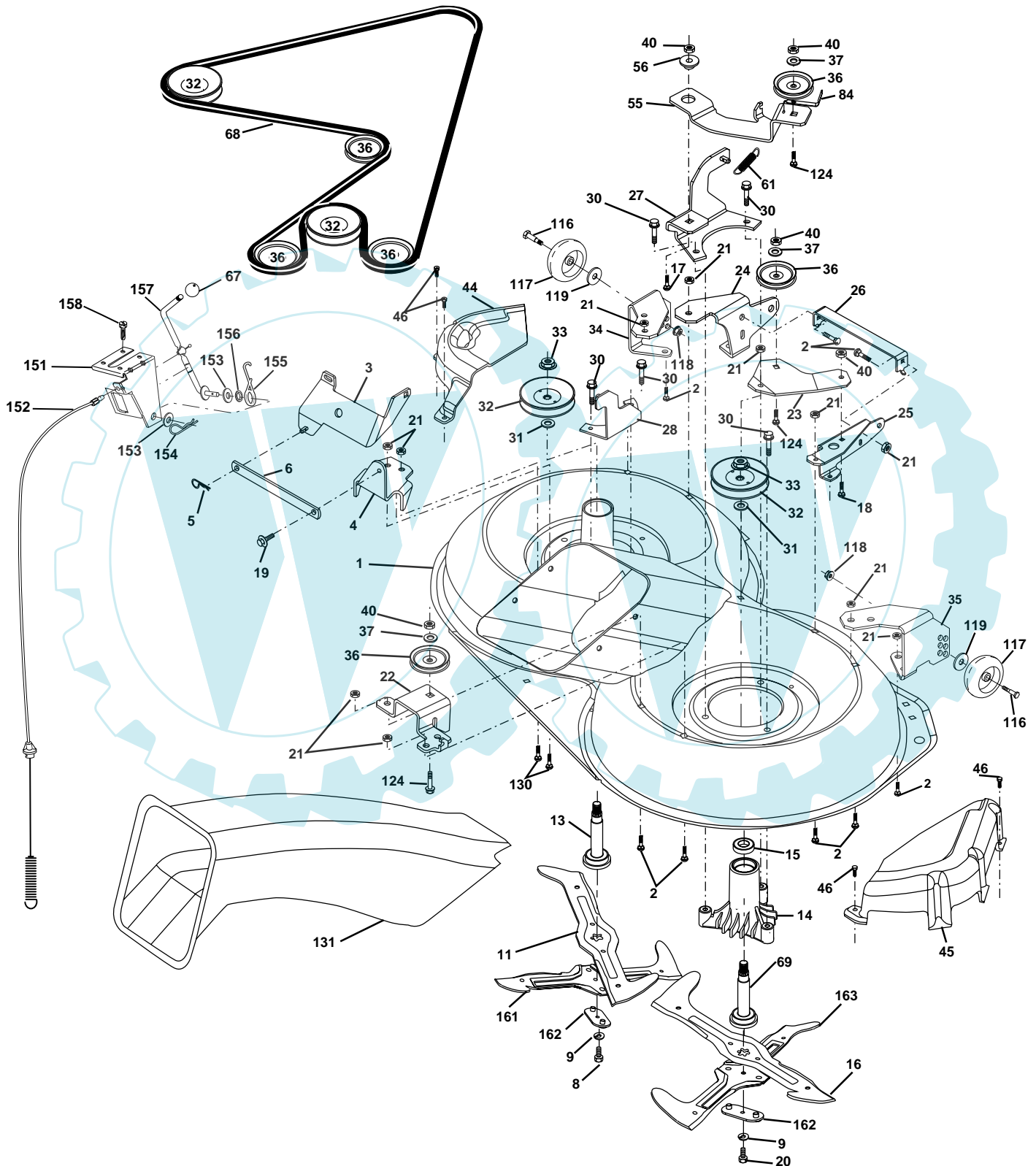

# REPAIR PARTS

**TRACTOR - - MODEL NO. BA12592RBA, PRODUCT NO. 964 77 46-00**  
**MOWER**

| KEY NO. | PART NO.     | DESCRIPTION                       | KEY NO. | PART NO.     | DESCRIPTION                     |
|---------|--------------|-----------------------------------|---------|--------------|---------------------------------|
| 1       | 532 16 55-52 | Housing Asm. Mower                | 44      | 532 17 55-38 | Cover Mandrel Lh                |
| 2       | 872 14 05-06 | Bolt Rdhd Sqnk 5/16-18 Unc x 3/4  | 45      | 532 17 55-39 | Cover Mandrel Rh                |
| 3       | 532 16 55-69 | Bracket Asm. S-Bar Chass          | 46      | 532 13 77-29 | Screw Thd Roll 1/4-20 x 5/8     |
| 4       | 532 16 55-58 | Bracket Bar Sway Deck             | 55      | 532 16 54-45 | Arm Idler                       |
| 5       | 532 12 46-70 | Retainer Spring                   | 56      | 532 16 57-23 | Spacer Retainer PM Mower        |
| 6       | 532 16 55-57 | Bar Sway                          | 61      | 532 16 59-45 | Spring Tension Belt             |
| 8       | 532 18 17-12 | Bolt 3/8-24 x 1.25 Gr8 Patched    | 67      | 532 10 69-32 | Knob Rd 3/8-16 Plstc Thds Blk   |
| 9       | 810 03 06-00 | Washer Lock Hvy 3/8 Unplated      | 68      | 532 18 02-17 | Hex-Belt 92 Mower               |
| 11      | 532 17 00-37 | Blade 3-1 Lh                      | 69      | 532 16 54-82 | Shaft Asm W/Lwr Brg Rh Thd CRD  |
| 13      | 532 13 76-45 | Shaft Asm. W/Lower Bearing        | 84      | 532 15 60-85 | Keeper Belt Idler               |
| 14      | 532 12 87-74 | Housing Mandrel Vented (Machd)    | 116     | 532 13 76-44 | Bolt Shoulder                   |
| 15      | 532 11 04-85 | Bearing Ball Mandrel              | 117     | 532 13 39-57 | Wheel Gage Donut Wide           |
| 16      | 532 17 00-38 | Blade 3-1 Rh                      | 118     | 873 93 06-00 | Nut Centerlock 3/8-16 Unc       |
| 17      | 872 14 06-10 | Bolt Carriage 3/8-16 x 1-1/4      | 119     | 819 12 14-14 | Washer 3/8 x 7/8 x 14 Ga.       |
| 18      | 872 11 06-08 | Bolt Rdhd Sqnk 3/8-16 x 1 Gr5     | 124     | 872 11 06-12 | Bolt Carr Sh 3/8-16 x 1-1/2 Gr5 |
| 19      | 532 13 28-27 | Bolt Shoulder 5/16-18 Thd Form    | 130     | 872 11 05-06 | Bolt Rdhdsqnk 5/16-18 Unc x 3/4 |
| 20      | 532 18 17-13 | Bolt 3/8-24 x 1.25 Gr8 Ptch Lhthd | 131     | 532 16 56-61 | Chute Bagger CRD                |
| 21      | 873 68 05-00 | Nut Crown Lock 5/16-18            | 151     | 532 16 96-70 | Bracket Clutch Cable            |
| 22      | 532 16 52-43 | Bracket Idler Sprt RR             | 152     | 532 17 60-74 | Cable Clutch CRD Service        |
| 23      | 532 16 54-46 | Bracket Idler Sprt RF             | 153     | 532 16 96-74 | Washer Flat 3/8" Type B         |
| 24      | 532 16 52-42 | Bracket Suspension LF             | 154     | 532 16 96-75 | Spring Retainer                 |
| 25      | 532 16 52-44 | Bracket Suspension RF             | 155     | 532 16 96-71 | Spring Retainer Lvr Cltch Cab   |
| 26      | 532 16 52-37 | Brace Support Susp Frt CRD        | 156     | 532 16 96-72 | Spacer Clutch Cable             |
| 27      | 532 16 55-68 | Bracket Asm. Susp RR              | 157     | 532 16 96-69 | Rod Clutch Cable 3/8"           |
| 28      | 532 16 55-67 | Bracket Asm. Susp LR              | 158     | 817 72 04-08 | Screw Hex Thdcut 1/4-20 x 5/8   |
| 30      | 532 17 39-84 | Screw Thd Rolling Washer Head     | 161     | 532 18 04-18 | Blade Cross Lh 92               |
| 31      | 532 12 99-63 | Washer Spacer Mower Vented        | 162     | 532 18 04-20 | Adapter Blade Cross             |
| 32      | 532 15 35-31 | Mandrel Pulleys 36 & 46           | 163     | 532 18 04-19 | Blade Cross Rh 92               |
| 33      | 532 17 83-42 | Nut Flg Top Lock                  | -       | 532 18 18-57 | Mandrel Asm Service             |
| 34      | 532 16 52-39 | Bracket Gauge Wheel Lf            | -       | 532 18 18-58 | Mandrel Asm CRD Lh Threads SVC  |
| 35      | 532 16 52-38 | Bracket Gauge Wheel Rf            | -       | 532 18 17-65 | Replacement Mower Complete      |
| 36      | 532 14 67-63 | Pulley Idler V-Groove Dim 4.25    |         |              |                                 |
| 37      | 819 13 13-16 | Washer 11/32 x 13/16 x 16 Ga      |         |              |                                 |
| 40      | 873 68 06-00 | Nut Crownlock 3/8-16 Unc          |         |              |                                 |

**NOTE:** All component dimensions given in U.S. inches  
 1 inch = 25.4 mm

# REPAIR PARTS

TRACTOR - - MODEL NO. BA12592RBA, PRODUCT NO. 964 77 46-00  
BAGGER

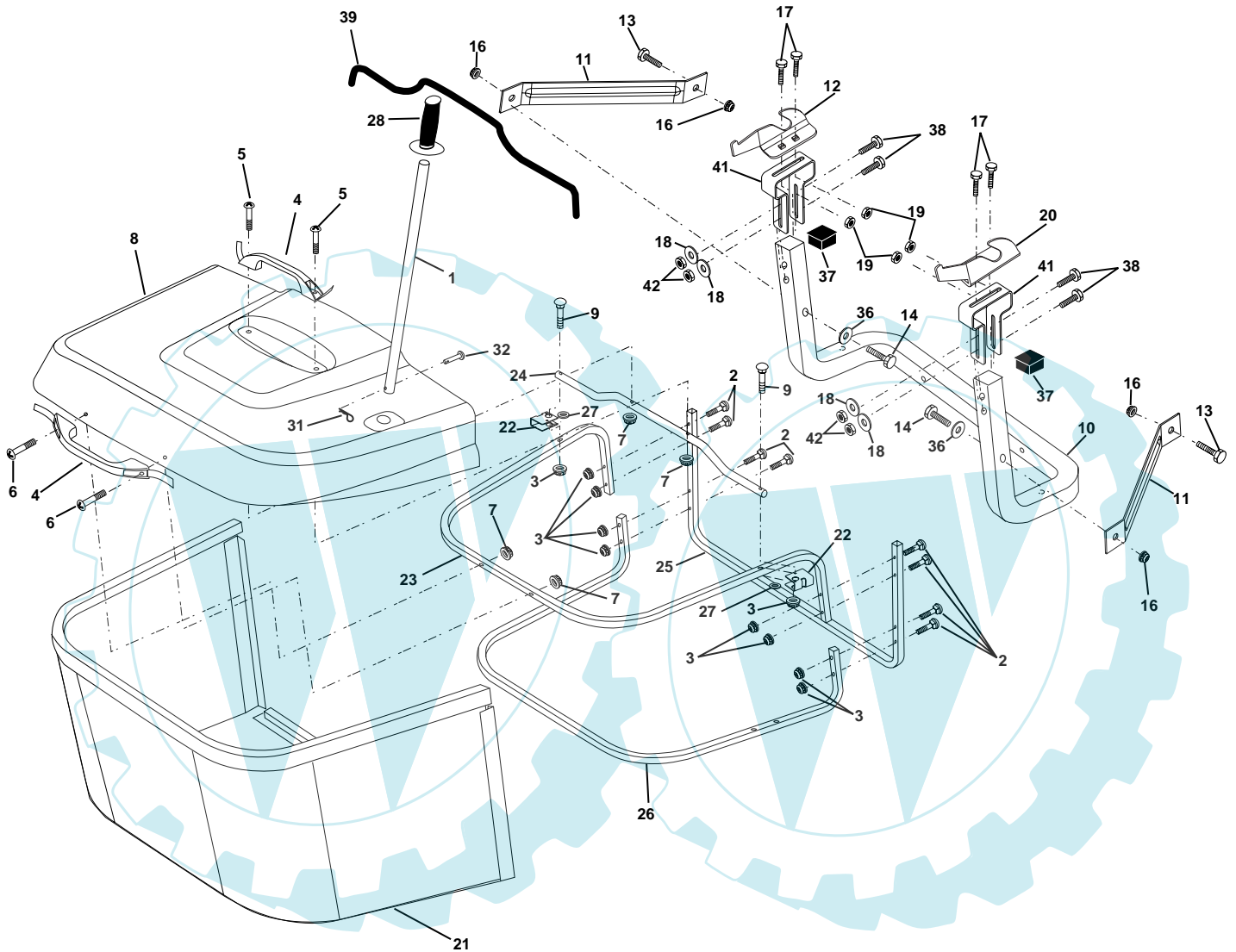



# REPAIR PARTS

TRACTOR - - MODEL NO. BA12592RBA, PRODUCT NO. 964 77 46-00  
BAGGER

| KEY NO. | PART NO.     | DESCRIPTION                         |
|---------|--------------|-------------------------------------|
| 1       | 532 16 52-49 | Tube Handle Bagger CRD              |
| 2       | 872 14 04-16 | Bolt Carriage 1/4-20 X 2.0 Gr.5     |
| 3       | 532 12 39-76 | Nut Lock 1/4 Lge Flg Gr. 5 Zinc     |
| 4       | 532 16 99-16 | Handle Bagger w/Lvrs Gr. 5 Zinc     |
| 5       | 874 98 10-24 | Screw Pan Head #10-24 X 1.50 Blk    |
| 6       | 874 98 10-32 | Screw Pan Hd                        |
| 7       | 873 40 10-00 | Nut Wiz Lock Hex Serr/Hd #10-24     |
| 8       | 532 18 25-14 | Cover Bagger Steel                  |
| 9       | 872 14 04-18 | Bolt Carriage 1/4-20 x 2.25d x Gr.5 |
| 10      | 532 18 12-82 | Tube Support Bagger CRD             |
| 11      | 532 16 57-19 | Bracket Support Upper Bag CRD       |
| 12      | 532 16 96-85 | Bracket Horiz. Adj Bagger           |
| 13      | 872 11 06-06 | Bolt Rdhd Sht Sqnk 3/8-16 X 3/4     |
| 14      | 874 52 06-36 | Bolt Fin Hex 3/8-16 X 2-1/4 Gr. 5   |
| 16      | 873 90 06-00 | Nut Lock Flg 3/8-16 Unc             |
| 17      | 872 14 05-06 | Bolt Rdhd Sht Sqnk 5/16-18Unc X 3/4 |
| 18      | 819 11 12-16 | Washer 11/32 x 3/4 x 16 Ga.         |
| 19      | 873 90 05-00 | Nut Lock Hex Flange 5/16-18         |
| 20      | 532 16 96-84 | Bracket Horiz Adj Bagger            |
| 21      | 532 18 08-80 | Bag Asm CRD                         |
| 22      | 532 16 57-81 | Bracket Side Bagger CRD             |
| 23      | 532 16 57-82 | Tube Upper Bagger CRD               |
| 24      | 532 16 57-83 | Tube Pivot Bagger CRD               |
| 25      | 532 18 01-24 | Tube Front Bagger CRD               |
| 26      | 532 16 57-85 | Tube Lower Bagger CRD               |
| 27      | 532 16 96-92 | Bushing Snap Bagger CRD             |
| 28      | 532 16 57-87 | Grip Handle Black                   |
| 31      | 532 12 47-88 | Retainer Spring 1" Zinc/Cad         |
| 32      | 532 12 68-75 | Rivet Rd Hd Drilled 3/8 Dia         |
| 36      | 819 13 20-16 | Washer 13/32 x 1-1/4 x 16 Ga.       |
| 37      | 532 17 54-01 | Plug Support Bagger CRD             |
| 38      | 872 01 05-20 | Bolt 5/16-18 x 2-1/2                |
| 39      | 532 18 09-85 | Seal Trim 37"                       |
| 41      | 532 16 96-83 | Bracket Vert Adj Bagger CRD         |
| 42      | 873 80 05-00 | Nut Lock Hx w/Ins 5/16-18 Unc       |

**NOTE:** All component dimensions given in U.S. inches  
1 inch = 25.4 mm

---

# SERVICE NOTES

---

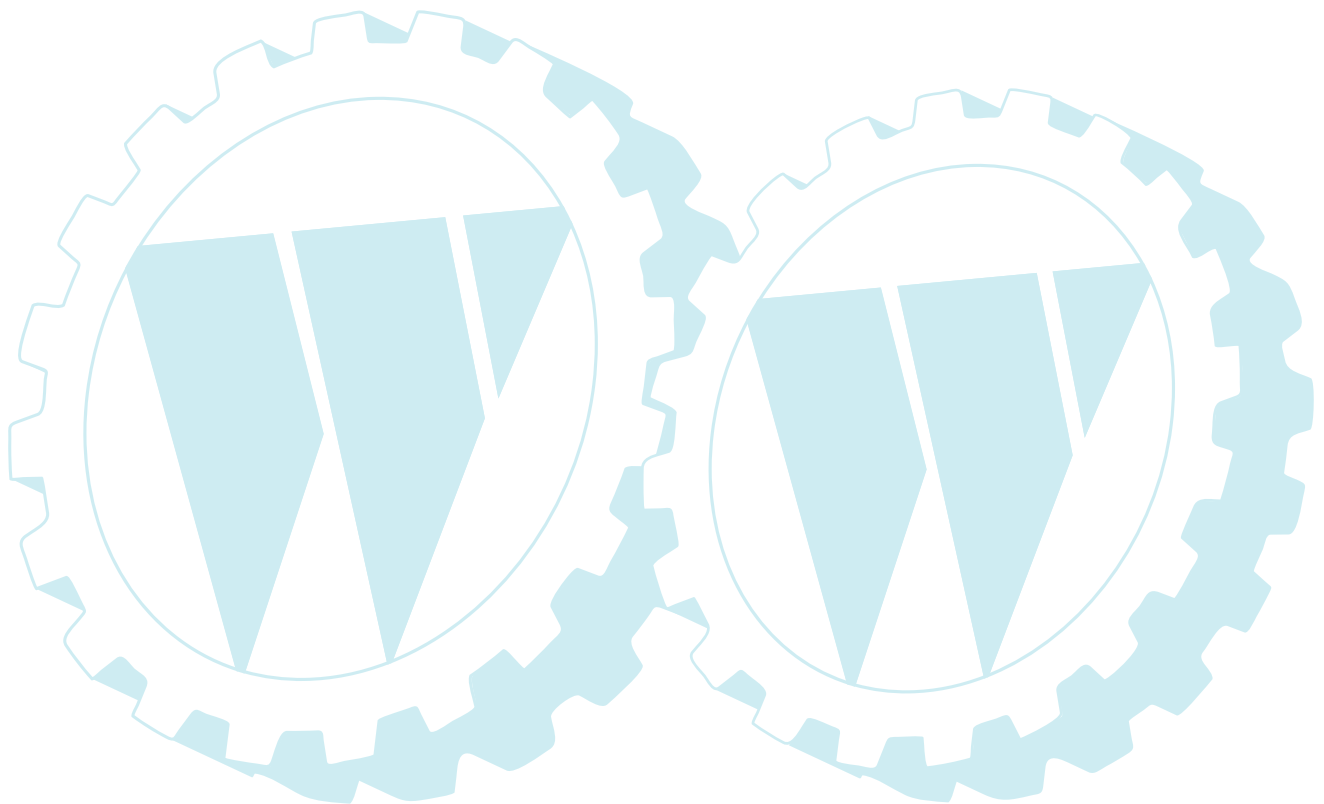

---

# SERVICE NOTES

---

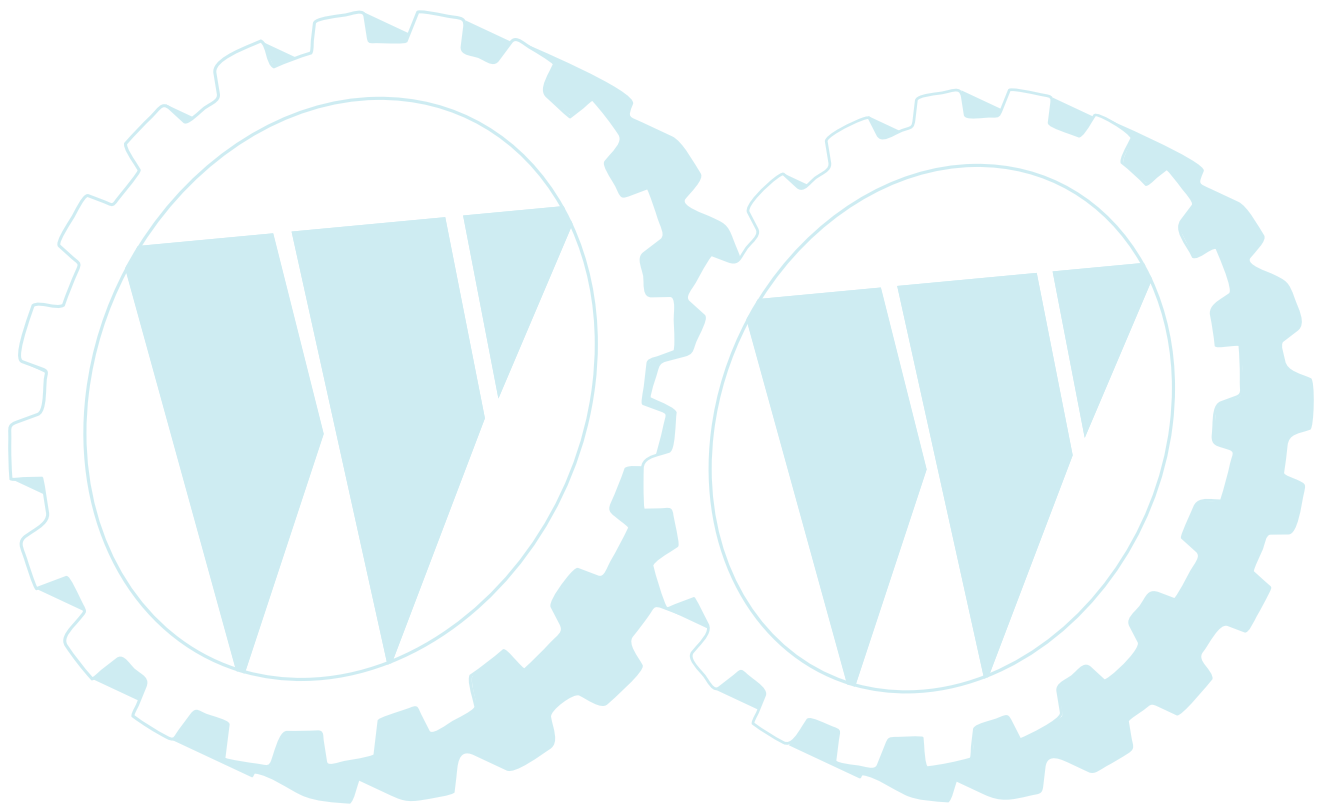

## Electrolux Outdoor Products Service Contacts

### BELGIQUE/BELGIË

Electrolux Outdoor Products  
Tel: 02 363 0311, Fax: 02 363 0391

### ČESKÁ REPUBLIKA

Electrolux, spol. s.r.o., oz Electrolux Outdoor Products,  
Dobronická 635, 148 25 Praha 4  
Tel: 02/6111 2408-9, Info-linka: 0800/110 220  
Internet: www.partner-flymo.cz E-mail: info@husqvarna.cz

### DANMARK

Electrolux Outdoor Products, Flymo/Partner A/S,  
Lundtoftegrdsvej 93A, DK 2800 Kgs.Lyngby  
Tel: 45 8775777, www.flymo-partner.dk

### DEUTSCHLAND

Electrolux Outdoor Products  
Tel: 097 21 7640, Fax:097 21 764202

### ESTONIA

Electrolux Estonia Ltd (Electrolux Eesti AS)  
Tel: (372) 6650010

### FRANCE

Electrolux Outdoor Products  
Tel 01 46 67 8141, Fax 01 43 34 2491

### FINLAND SUOMI

Electrolux Outdoor Products Finland  
Tel: 00 39611, Fax: 00 39 612632

### ITALIA

McCulloch Italiana s.r.l. - Via Como 72, 23868 Valmadrera  
(LECCO) - ITALIA, Tel: 800 017829, Fax: 0341 581671

### IRELAND

Electrolux Outdoor Products  
Tel: 01 4565222, Fax: 01 4568551

### MAGYARORSZÁG

Electrolux Lehel Kft  
Tel: 00 36 1 251 41 47

### NORGE

Electrolux Outdoor Products  
Tel: 69 10 47 90

### NEDERLAND

Electrolux Outdoor Products BV  
Tel: 0172-468322, Fax: 0172-468219

### ÖSTERREICH

HUSQVARNA Zentralwerksttte, Industriezeile 36, 4020 LINZ,  
Tel: 0732 770101-60, Fax: 0732 795922

### POLSKA

Electrolux Poland Sp. z.o.o. Husqvarna, 01-612 Warszawa  
Myslowicka 10/2  
Tel:- (22) 8332949

### SLOVENIJA

SKANTEH d.o.o.  
Tel:- (061) 133 70 68, Fax:-(061) 133 70 68

### SLOVENSKA

Electrolux Slovakia s.r.o., Borova Sihot 211, 033 01 Lipt. Hradok  
Tel: 044 522 14 19, Fax: 044 522 14 18, www.flymo-partner.sk

### SCHWEIZ/SUISSE/SUIZZERA

Electrolux Outdoor Products  
Tel 062 889 93 50 / 889 94 25, Fax 062 889 93 60 / 889 94 35

### SVERIGE

Electrolux Outdoor Products, Sverige  
Tel: 036 ù 14 67 00, Fax: 036 ù 14 60 70

### UNITED KINGDOM

Electrolux Outdoor Products, United Kingdom  
Tel: 01325 300303, Fax: 01325 310339